

RT SERIES

HYDRAULISCHE SLEUTELS MET VIERKANTE DRIVER

ALUMINIUM MONOBLOC LICHAAM

Verlicht de massa van het gereedschap en biedt een grote weerstand tegen een hoog koppel. Deze specificatie geeft een licht gewicht/hoog vermogen.

GEMONTEERDE KAP MET VERING

Dit systeem staat toe om de kinetische krachten te absorberen. Kwaliteit tot in de kleinste details.

VRIJE HANDBEDIENING

Uni directioneel ratelsysteem met anti-retour voor een vrije handbediening.

VIERKANTE DRIVER

De uniforme krachtverdeling op 360° levert een nauwkeurige koppel en levert een weerstand aan alle uitdagingen voor de vierkante driver.

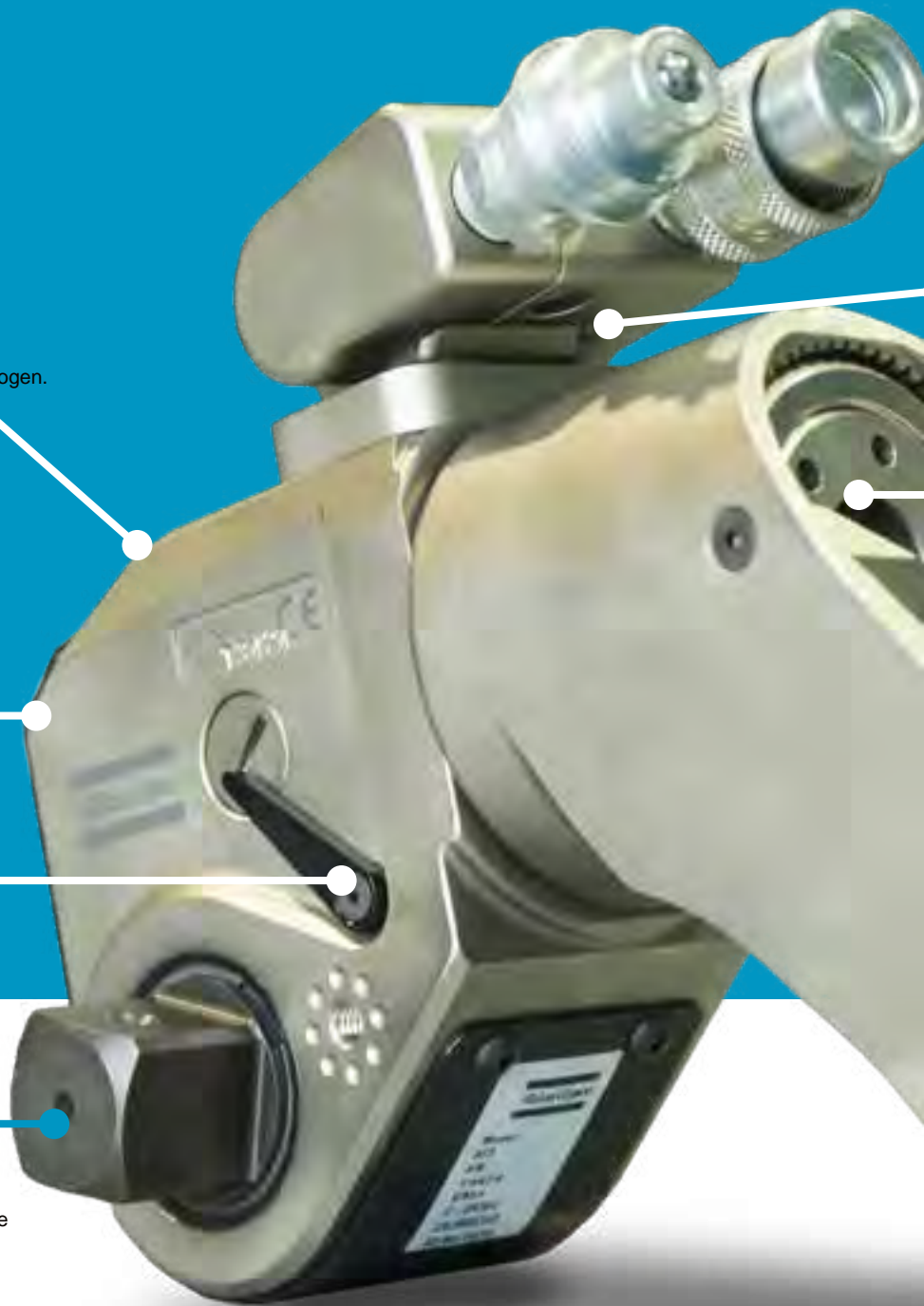

RT-modellen bieden een hoog koppel en veiligheid onder alle omstandigheden.
Er zijn 9 modellen met een aanhaalnauwkeurigheid van +/- 3%



SWIVEL 360°X160°
Maakt een eenvoudige en veilige bediening mogelijk in alle posities.

GETAND REACTIEARM
Staat aanpassing van het reactiepunt toe terwijl deze zonder moeite bedient kan worden met handschoenen.

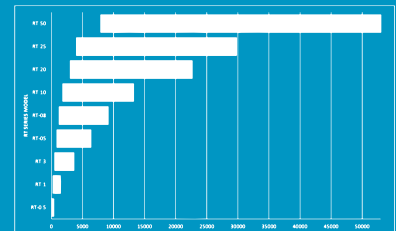

Draaiende vierkant

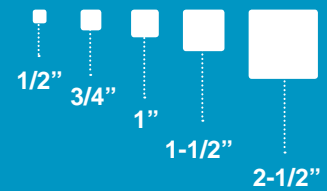

REACTIEVOET IN STAAL
Kan ook worden aangepast of geleverd in koper

RT SERIES TECHNISCHE INFORMATIE



Model	Koppel								Referenties
	Draaiende vierkant in	ft. lb.		Nm		Gewicht			
		min	max	min	max	lb	kg		
RT-0.5	1/2	55	397	75	538	0.8	0.4	8434 2010 00	
RT-01	3/4	200	1340	271	1817	3.8	1.9	8434 2010 02	
RT-03	1	480	3230	651	4379	7.8	3.9	8434 2010 05	
RT-05	1-1/2	835	5590	1132	7578	15	7.5	8434 2010 09	
RT-08	1-1/2	1200	8000	1627	10845	23	11.5	8434 2010 13	
RT-10	1-1/2	1755	11520	2379	15617	26.8	13.4	8434 2010 16	
RT-20	2-1/2	2960	19760	4013	26787	36	18	8434 2010 20	
RT-25	2-1/2	3960	25890	5368	35096	62	31	8434 2010 25	
RT-50	2-1/2	7875	52500	10675	71169	96	48	8434 2010 29	

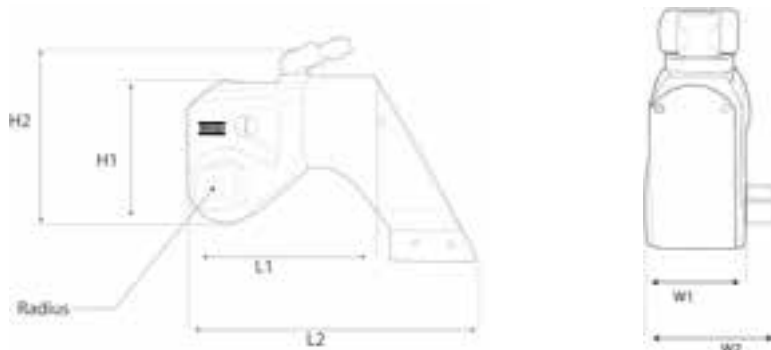

Model	Afmetingen													
	L1		L2		H1		H2		Straal		W1		W2	
	in	mm	in	mm	in	mm	in	mm	in	mm	in	mm	in	mm
RT-0.5	3.15	81	4.87	125	2.35	60.5	3.62	93	0.52	13.5	1.3	33.5	1.97	50.5
RT-01	4.68	120	7.13	183	3.52	90.5	4.75	122	0.9	23	1.95	50	2.76	71
RT-03	6.04	155	9.24	237	4.68	120	6.08	156	1.28	33	2.59	66.5	3.72	95.5
RT-05	7.21	185	11.23	288	5.63	144.5	7.05	181	1.44	37	3.12	80	4.9	126
RT-08	7.85	202	12.49	321	6.42	164.6	8.4	213.36	1.62	41	3.48	88	4.95	126
RT-10	9	232	13.9	357	7.2	186	9.3	239	1.87	48	3.9	100	5.5	142.5
RT-20	10.2	259	16.55	420	8.5	216	9.9	251	2.17	55.1	4.7	119	6.7	170
RT-25	12	310	18.4	473	9.1	234	11	282	2.37	61	5.2	134	7.4	191
RT-50	15.2	390	23.9	615	11.4	294	13.4	344	30.8	79	6.5	167	8.9	228

Afmetingen en specificaties kunnen zonder voorafgaande kennisgeving worden gewijzigd.

Getallen die niet geheel zijn afgerond kunnen afwijken van de werkelijke afmetingen.

HULPSTUKKEN VOOR RT SERIES

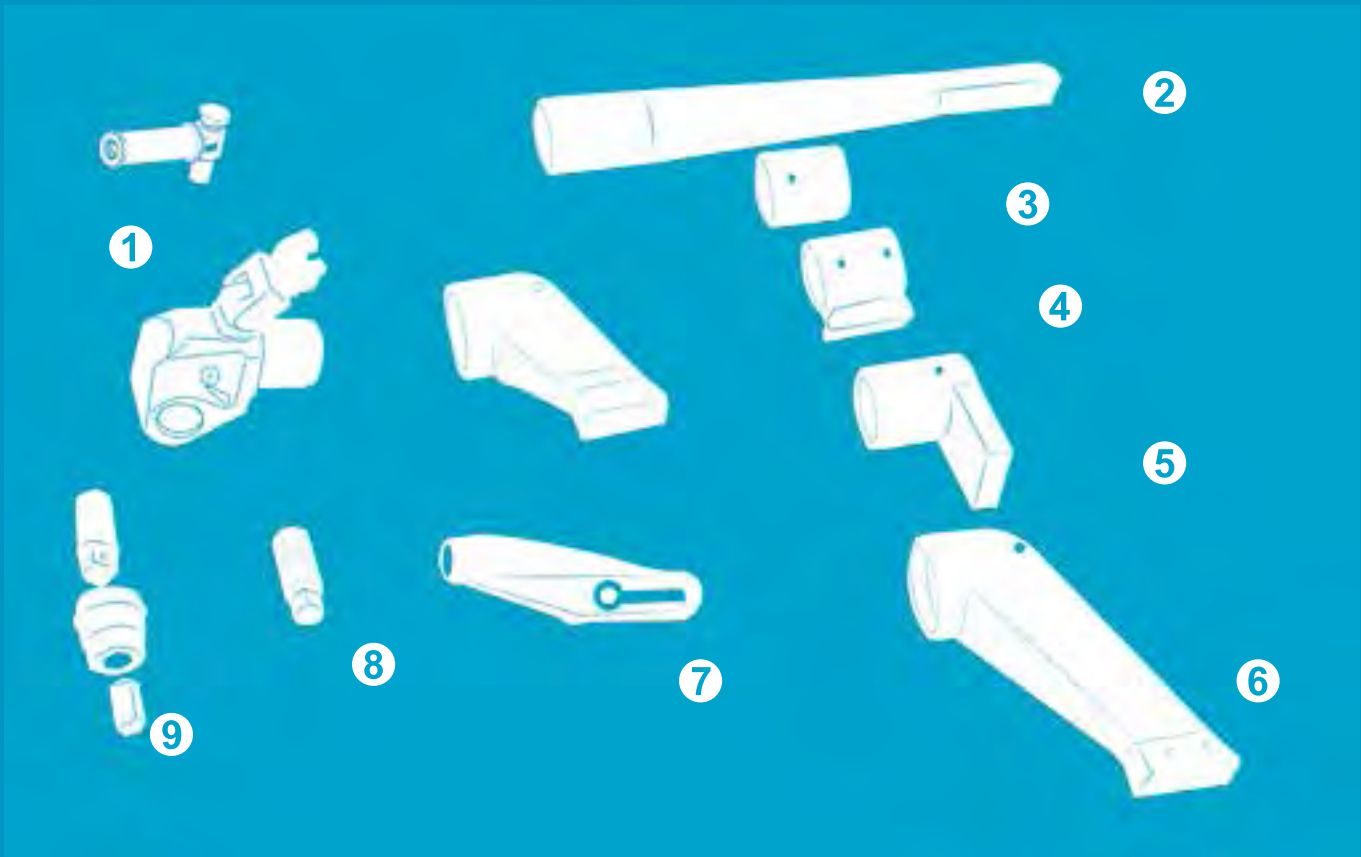

① RT Safety Handle

② Alco Reaction Arm

③ Steel Reaction Sleeve

④ Steel Reaction Sleeve with Foot

⑤ CAM-style Reaction Arm

⑥ Extended Reaction Arm

⑦ Sliding Reaction Arm

⑧ Direct Hex Drive

⑨ Insert Bit Adapter

1 SAFETY HANDLE



Omschrijving	Referenties
Handle Kit RT0.5, RT1	8434 2170 34
Handle Kit RT3, RT5	8434 2170 33
Handle Kit RT8, RT10	8434 2170 32

2 ALCO ARM



Omschrijving	Referenties
RT0.5-ALC	4222 2126 76
RT01-ALC	4222 2102 64
RT03-ALC	8434 2057 10
RT05-ALC	8434 2139 88
RT08-ALC	8434 2140 36
RT10-ALC	8434 2140 60

3 STEEL SLEEVE



Omschrijving	Referenties
RT0.5-SSLV	4222 2126 88
RT01-SSLV	8434 2057 08
RT03-SSLV	8434 2057 32
RT05-SSLV	8434 2140 30
RT08-SSLV	8434 2140 51
RT10-SSLV	8434 2140 90

4 STEEL SLEEVE W/FOOT



Omschrijving	Referenties
RT01-SSLVF	8434 2057 09
RT03-SLVF	4222 2130 21

5 CAM STYLE ARM



Omschrijving	Referenties
RT03-CAM ARM	4222 2130 12
RT05-CAM ARM	4222 2130 57

RT SERIES ONDERDELEN

6 EXT ARM



Omschrijving	Referenties
RT0.5-EXT	4222 2126 82
RT01-EXT	8434 2056 92
RT03-EXT	8434 2057 12
RT05-EXT	8434 2057 34
RT08-EXT	8434 2140 42
RT10-EXT	8434 2140 66

7 SLIDING REACTION ARM



Omschrijving	Referenties
RT-01 Sliding Ext	8434 2057 33
RT-01 Sliding Std	8434 2150 95
RT-03 Sliding Ext	8434 2150 37
RT-03 Sliding Std	8434 2150 30
RT-05 Sliding Ext	8434 2150 36
RT-05 Sliding Std	8434 2150 35
RT-08 Sliding Ext	8434 2150 32
RT-08 Sliding Std	8434 2150 31
RT-10 Sliding Ext	8434 2150 34
RT-10 Sliding Std	8434 2150 33

STD= Standard

EXT=Extended

Omschrijving	Referenties
RT20 Sliding Ext	8434 2150 90
RT20 Sliding Std	8434 2150 89
RT25 Sliding Ext	8434 2150 92
RT25 Sliding Std	8434 2150 91
RT50 Sliding Ext	8434 2150 94
RT50 Sliding Std	8434 2150 93

RT SERIES ONDERDELEN INFORMATIE

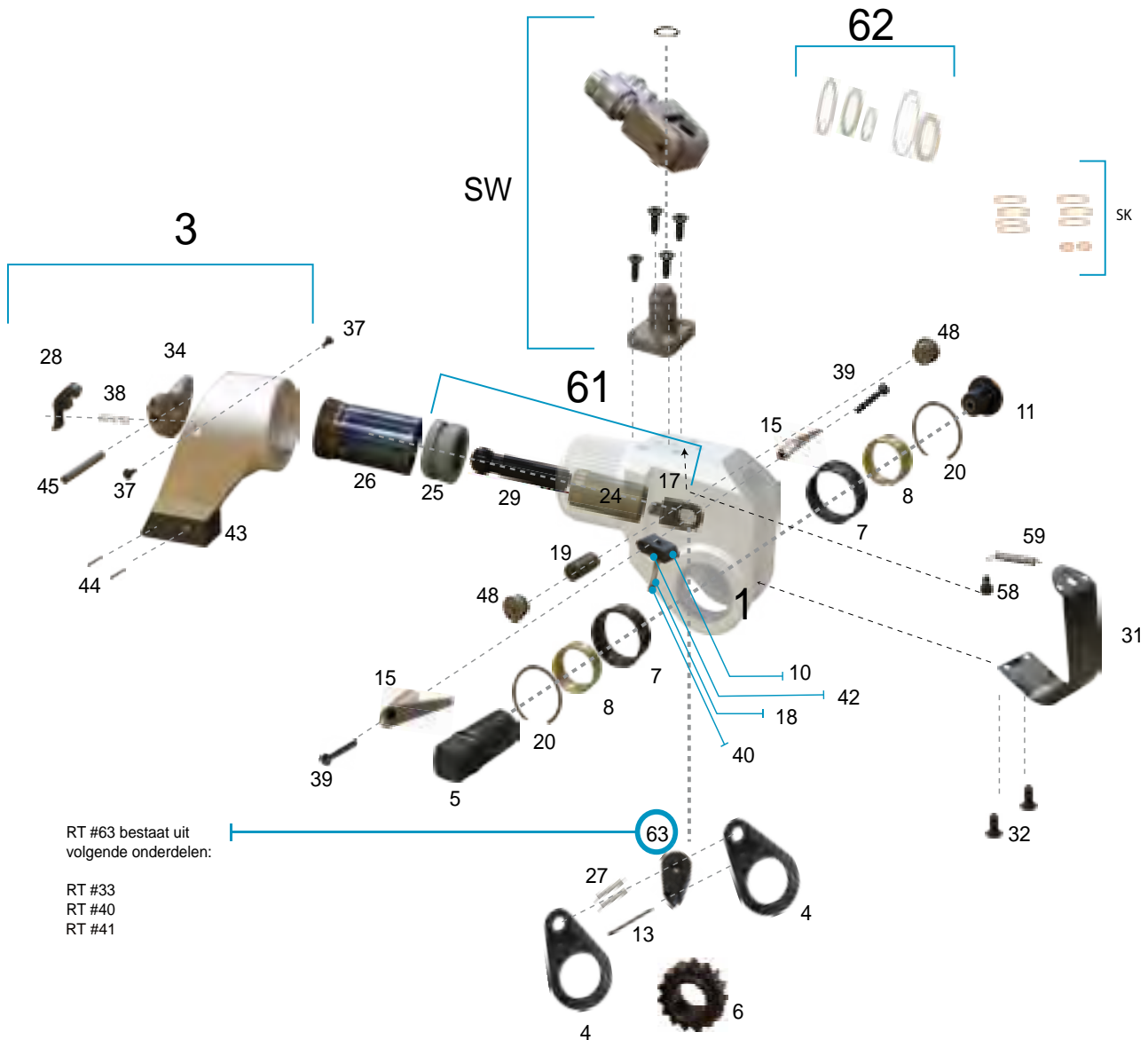

Een periodiek onderhoud wordt aanbevolen om nauwkeurigheid, veiligheid en levensduur van je sleutel te garanderen. Onze techniekers zijn experts die de optimale kwaliteit van uw gereedschap in stand zullen houden voor de duur van uw operaties. U kunt ook onze onderhoudskit bestellen.

Lijst onderdelen

Item	Omschrijving	Referentie
1*	Housing	RT#-1
3	Reaction Arm Assembly	RT#-3
4	Drive Plate	RT#-4
5	Square Drive	RT#-5
6	Ratchet Spine	RT#-6
7	Drive Bushing	RT#-7
8	Drive Sleeve Spline	RT#-8
10	Reaction Pawl	RT#-10
11	Drive Retainer	RT#-11
13	Drive Plate Roll Pin	RT#-13
15	Disengagement Lever	RT#-15
17	Piston Rod End	RT#-17
18	Reaction Pawl Spring	RT#-18
19	Rod End Pin	RT#-19
20	Drive Sleeve Retaining Ring	RT#-20
24	Piston Sleeve	RT#-24
25	Piston with Seal	RT#-25
26	Cylinder End Cap	RT#-26
27	Drive Pawl Spring	RT#-27
28	Reaction Arm Lever	RT#-28
29	Piston Rod	RT#-29
31	Shroud	RT#-31
32	Shroud Screw	RT#-32
33	Secondary Drive Pawl Spring	RT#-33
34	Reaction Arm Plate	RT#-34
37	Reaction Arm Plate Screw	RT#-37
38	Reaction Arm Lever Spring	RT#-38
39	Disengagement Lever Screw	RT#-39
40	Primary Drive Pawl Roll Pin	RT#-40
41	Secondary Drive Pawl Pin	RT#-41
42	Reaction Pawl Roll Pin	RT#-42
43	Reaction Arm Boot with Pins	RT#-43
44	Reaction Arm Boot Pin	RT#-44
45	Reaction Arm Lever Pin	RT#-45
48	Access Plug	RT#-48
58	Shroud Spring Screw	RT#-58
59	Shroud Spring	RT#-59
61	Piston Rod Assembly	RT#-61
62	Housing Seal Kit	RT#-62
63	Drive Pawl Assembly	RT#-63
SW*	Swivel Assembly (Small, Medium or Large)	RT-SW
SK	Swivel Seal Kit (Small, Medium or Large)	RT-SK

RT Series onderhoudskits

Item	Omschrijving	Referentie
RT0.5-MK	Maintenance Kit	4222 2126 85
RT01-MK	Maintenance Kit	4222 2127 36
RT03-MK	Maintenance Kit	8434 2139 73
RT05-MK	Maintenance Kit	4222 2127 78
RT08-MK	Maintenance Kit	4222 2105 52
RT10-MK	Maintenance Kit	8434 2140 87
RT20-MK	Maintenance Kit	8434 2057 56
RT25-MK	Maintenance Kit	4222 2116 31
RT50-MK	Maintenance Kit	4222 2116 34

De onderhoudskits worden geleverd met de nodige onderdelen die u een goede werking van uw sleutels voorzien.

Onderhoudskit:

Disengagement Lever w/Screws
 Drive Sleeve Retaining Ring
 Shroud
 Reaction Arm Plate Screws
 Disengagement Lever screw
 Access Plug (if applicable)
 Shroud Spring Screw
 Housing Seal Kit
 Roll Pin Kit
 Spring Kit
 Medium Swivel Seal Kit
 Male Female Nipple
 Female Coupler

RTX SERIES

HYDRAULISCHE CASSETTESLEUTELS

ALUMINIUM MONOBLOC LICHAAM

Verlicht de massa van het gereedschap en biedt een grote weerstand tegen een hoog koppel.

Deze specificatie geeft de verhouding gewicht / hoog vermogen.

HOGE KWALITEIT STAALLEGERING

Voor de veeleisende werken.

GEGARANDEERDE ZELFDE KOPPEL

Voor eender welke cassette.

DE KLEINSTE STRAAL IN ZIJN CATEGORIE!

Staat de bediening toe in de meest beperkte ruimtes.

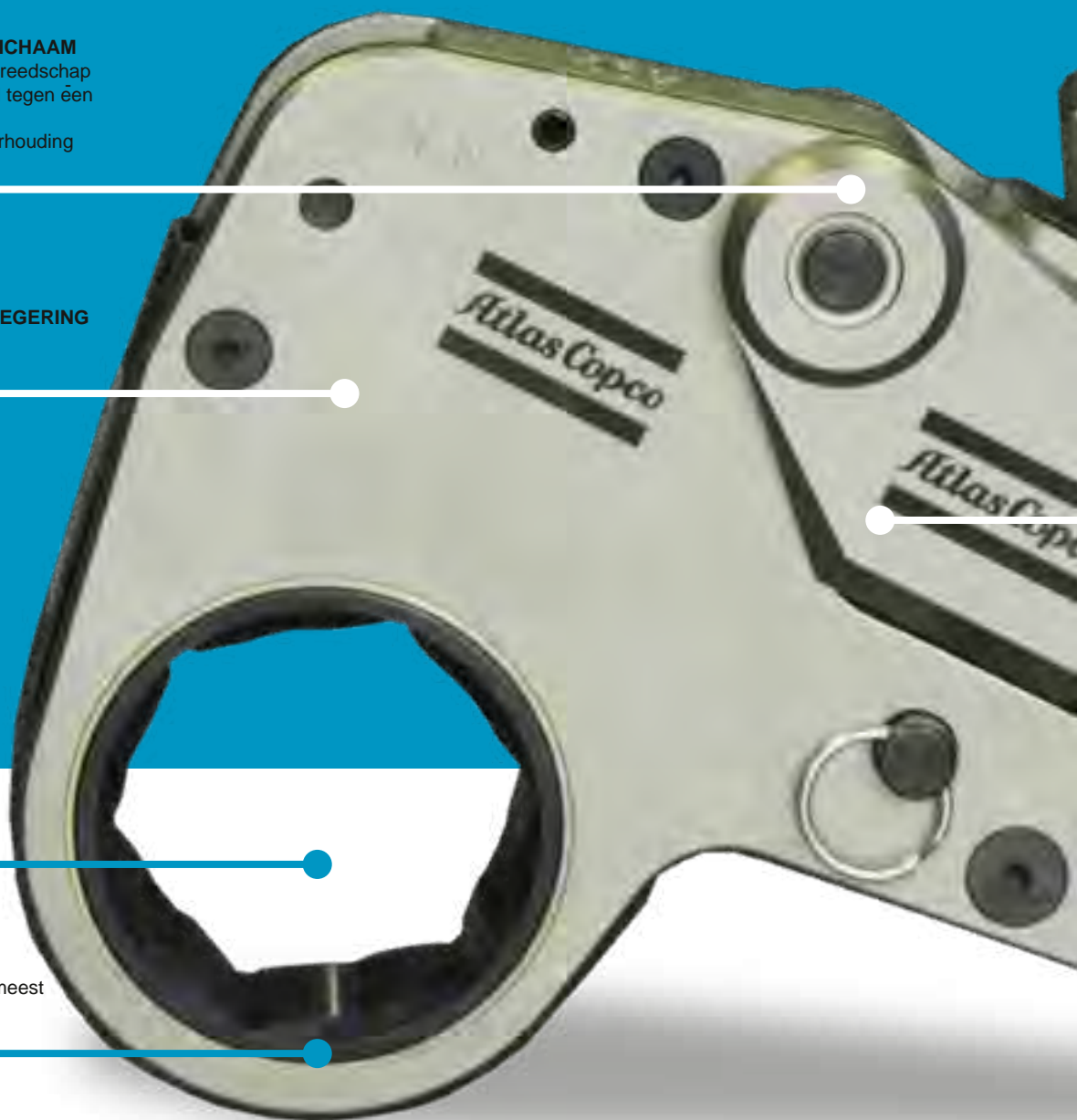

De RTX-serie elimineert toegangsproblemen en maakt eenvoudige bediening mogelijk.
Herhaalbaarheid bij 1% en nauwkeurigheid van +/- 3%



SWIVEL 360°X160°
Maakt een eenvoudige en veilige bediening mogelijk
in alle posities.

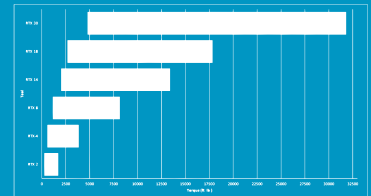

AUTOMATISCHE INWERKSTELLING
De kop grijpt automatisch in
met de cassette tijdens de eerste cyclus van de zuiger.

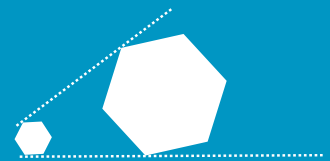

Ranges from 3/4" to 6 1/2"

MOGELIJKE REACTIEOPTIES
De reactietijd op de cassette is zeer accuraat.
Andere opties zijn eveneens mogelijk.

RTX SERIES TECHNISCHE INFORMATIE

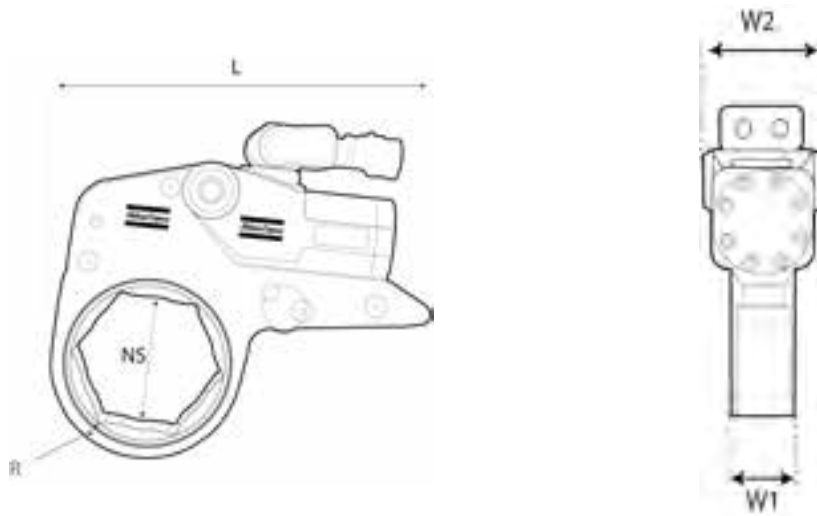

Model	Afmetingen									
	L		Afmeting v/d moer		R		W1		W2	
	in	mm	in	mm	in	mm	in	mm	in	mm
RTX-02	7.2	183	3/4 – 2-9/16	19-65	0.35	9	1.26	32	1.92	49
RTX-04	9.7	248	1-5/16 - 3-1/8	32-80	0.47	12	1.65	42	2.56	65
RTX-08	12.1	308	1-13/16 - 3-7/8	46-100	0.59	15	2.08	53	3.22	82
RTX-14	14.6	372	2 – 4-5/8	50-120	0.72	18.5	2.48	63	3.89	99
RTX-18	15.5	393	3 - 5-1/2	75-140	.87	22.2	2.75	70	4.37	111
RTX-30	18	457	3-9/16- 6-1/8	90-155	1	25.4	3.26	83	5.28	132

Model	Afmeting cassettes*		Koppel		Gewicht		Referenties
	in	mm	ft.lb.	Nm	lb	kg	
RTX-02	3/4 – 2-3/4	19-65	255-1710	346-2318	4.5	2	8434 2021 90
RTX-04	1 - 3-1/8	25-85	580-3855	786-5226	9.7	4.4	8434 2021 95
RTX-08	1-5/8 - 4-1/8	46-105	1143-8151	1549-11049	19.5	9	8434 2022 00
RTX-14	2-1/2 – 5-3/8	60-135	2010-13400	2725-18165	33	15	8434 2116 58
RTX-18	3-1/2 -5-1/2	75-140	2676-17845	3628-24191	51	23	8434 2022 05
RTX-30	3-1/2 -6-1/2	90-165	4770-31800	6466-43108	78	35.5	8434 2022 10

Afmetingen en specificaties kunnen zonder voorafgaande kennisgeving worden gewijzigd.
 Gelieve de veiligheidsinstructies voor gebruik te lezen.

KIES UW HYDRAULISCHE SLEUTEL RTX SERIES

1

RTX Powerhead

Kies uw model op basis van het gewenste koppel.

2

Direct Fit Ratchet Links

kies uw cassette die compatibel is met het model volgens de grootte van uw moer.

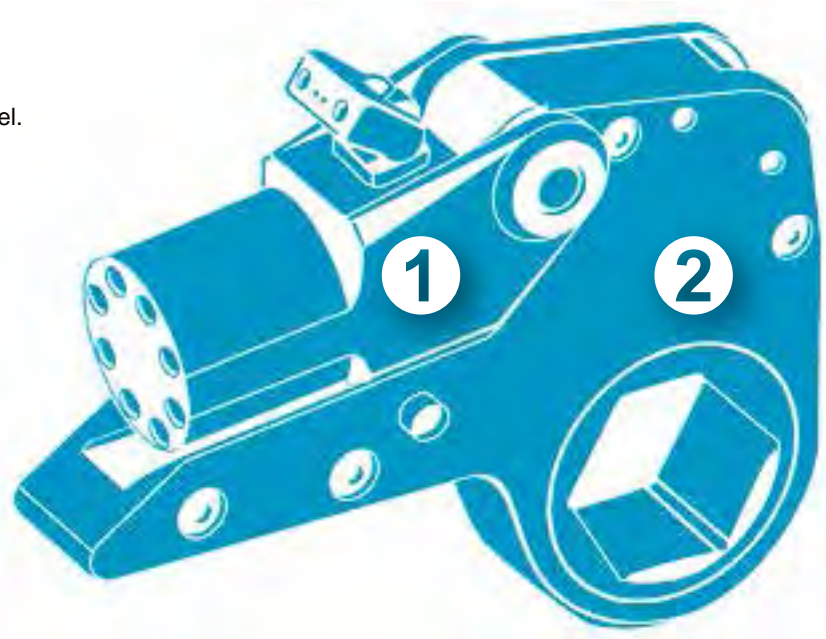

Hoe de juiste maat selecteren voor uw cassette ? *

In deze catalogus worden de maten uitgedrukt in mm, zowel voor metrische maten als de imperiale maten, ze worden uitgedrukt met drie cijfers. Hieronder een voorbeeld:

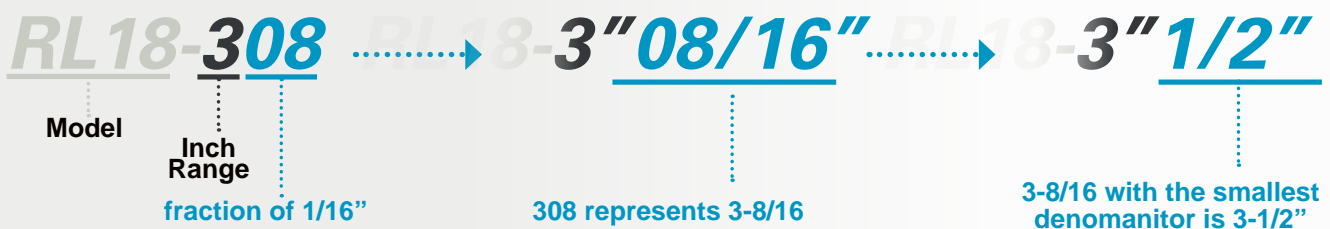

Het eerste cijfer is uitgedrukt in inches ,de twee volgende cijfers de hoeveelheid breuken in 16^{de} te vertalen naar de kleinste noemer.

*Alle RTX-modellen hebben een ongewijzigde koppel onafhankelijk van de gebruikte cassette.

RTX SERIES ONDERDELEN

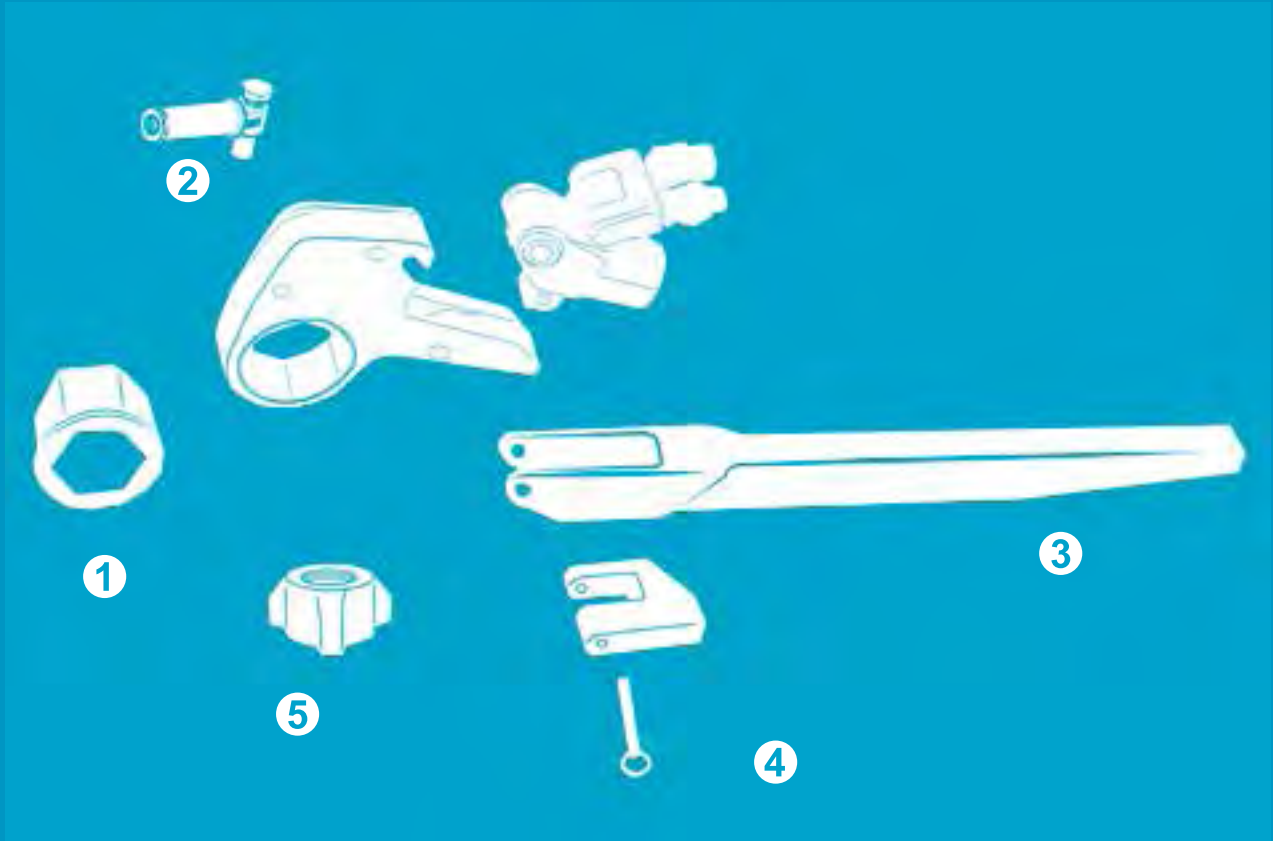

- ① Insert Hex Reducer
- ② Safety Handle for RTX
- ③ Alco Arm
- ④ Onside Reaction Arm
- ⑤ Safety Nut

1 INSERT HEX REDUCTIE



Starting Size	Reduces To	Referenties
2 3/4	1 5/8	4222 2134 17
2 3/4	1 13/16	4222 2134 20
2 3/4	1 7/8	4222 2134 23
46mm	36mm	4222 2134 26
50mm	41mm	4222 2134 29
50mm	46mm	4222 2134 32
1 13/16	30mm	4222 2119 58
1 13/16	36mm	4222 2119 62
1 13/16	42mm	4222 2119 66
2	1 3/4	4222 2137 74
2	1 13/16	4222 2137 77
2 1/4	1 5/16	4222 2137 80
2 1/4	1 1/2	4222 2137 83
2 1/4	1 7/8	4222 2137 86
2 1/2	1 7/8	4222 2119 70
2 3/4	2 1/2	4222 2137 89
2 3/4	2 1/16	4222 2137 92
2 3/4	2 1/8	4222 2137 95
2 3/4	2 3/16	4222 2137 98
2 3/4	2 1/4	4222 2138 01
2 3/4	2 3/8	4222 2138 04

Starting Size	Reduces To	Referenties
2 15/16	2 9/16	4222 2138 07
3 1/8	1	4222 2138 10
3 1/8	1 1/2	4222 2138 13
3 1/8	1 5/8	4222 2138 16
3 1/8	1 3/4	4222 2138 19
3 1/8	2	4222 2138 22
3 1/8	2 3/8	4222 2138 25
50mm	19mm	4222 2138 28
50mm	32mm	4222 2138 31
50mm	41mm	4222 2138 34
50mm	42mm	4222 2138 37
50mm	46mm	4222 2138 40
55mm	50mm	4222 2138 43
65mm	55mm	4222 2119 74
70mm	60mm	4222 2119 78
70mm	65mm	4222 2119 82
100mm	80mm	4222 2140 62
2 3/16	2	4222 2140 65
3 1/8	2 15/16	4222 2140 68
3 1/8	50mm	4222 2140 71
3 1/8	55mm	4222 2140 74
3 1/8	60mm	4222 2140 77
3 7/8	3 1/2	4222 2140 80
60mm	50mm	4222 2122 07
60mm	55mm	4222 2122 11
70mm	46mm	4222 2140 83

Alle maten zijn op aanvraag beschikbaar.

2 SAFETY HANDLE



Model	Referenties
Handle Kit RT-02	8434 2170 35
Handle Kit RT-04	8434 2170 36
Handle Kit RT-08	8434 2170 37
Handle Kit RT-14	8434 2170 38
Handle Kit RT-18	8434 2170 39
Handle Kit RT-30	8434 2170 40

3 ALCO ARM



Model	Referenties
RTX02-ALC	8434 2057 58
RTX04-ALC	8434 2057 60
RTX08-ALC	8434 2057 62
RTX14-ALC	8434 2057 64
RTX18-ALC	8434 2057 66
RTX30-ALC	8434 2057 67

4 ONSIDE REACTION ARM



Model	Referenties
RTX02-14	4222 2107 14
RTX04-14	4222 2109 27
RTX08-14	4222 2110 44
RTX14-14	4222 2141 22
RTX18-14	4222 2141 23
RTX30-14	4222 2144 43

5 SAFETY NUT



Stud Size	Referenties
2"	8434 2129 19
2-1/2"	8434 2129 18
2-1/4"	8434 2129 16
1-7/8"	8434 2129 15
3"	8434 2129 13
2-3/4"	8434 2129 12
1-3/4"	8434 2129 10
1-5/8"	8434 2129 09
1-1/2"	8434 2129 07
1-3/8"	8434 2129 06
1-1/4"	8434 2129 04
1-1/8"	8434 2129 03
1"	8434 2129 01
7/8"	8434 2129 00



Kies uw model.



Kies het bevestigingssysteem afhankelijk van het model.



Kies uw moersleutel.

Gesloten moersleutel met 12 punten.



OPEN MOERSLEUTEL

Open model met 12 punten.

RTX POWERHEAD ONDERDELEN



Een periodiek onderhoud wordt aanbevolen om de nauwkeurigheid, veiligheid en de levensduur van je sleutel te garanderen. Onze techniekers zijn experts die de optimale kwaliteit van uw gereedschap in stand zullen houden voor de duur van uw operaties. Je kunt ook onze onderhoudskit bestellen.

Powerhead items

#	Omschrijving	Referentie
1*	Housing	RTX-#-01
2	End Cap	RTX-#-02
3	Rod End	RTX-#-05
4	Piston Rod	RTX-#-06
5	Cylinder End Cap Screw	RTX-#-07
6	Fixed Upper Pin	RTX-#-08
7	Fixed Upper Pin Ring	RTX-#-09
8	Link Pin Short	RTX-#-10
9a	Link Pin Long for Alco Reaction Arm	RTX-#-11
9b	Link Pin Extra Long for On Side Reaction Arm	RTX-#-11XL
10	Link Pin Retainer	RTX-#-12
11	Housing Seal Kit	RTX-#-13
12*	Swivel Assembly (Small, Medium or Large)	RTX-SW
13	Swivel Seal Kit (Small, Medium or Large)	RTX-SK

Powerhead onderhoudskits

Model	Omschrijving	Bestel Nr
RTX02-MK	Maintenance Kit	4222 2134 35
RTX04-MK	Maintenance Kit	4222 2138 46
RTX08-MK	Maintenance Kit	4222 2141 07
RTX14-MK	Maintenance Kit	4222 2143 47
RTX18-MK	Maintenance Kit	4222 2144 25
RTX30-MK	Maintenance Kit	4222 2145 51

De onderhoudskit bestaat uit:

Housing Seal kit, Swivel Seal Kit, Link Pin for Alco Arm (if applicable), Link Pin Standard, Cylinder End Cap Screw, Fixed Upper Pin, Fixed Upper Ring, Rod End, Link Pin Retainer, 10,000psi/700bar Male & Female Coupler.

RL RATCHET LINK ONDERDELEN



Ratchet Link Onderhoudskits

Model	Omschrijving	Referenties
RL02-MK	Ratchet Link Maintenance Kit	8434 2132 95
RL04-MK	Ratchet Link Maintenance Kit	8434 2134 57
RL08-MK	Ratchet Link Maintenance Kit	8434 2059 53
RL14-MK	Ratchet Link Maintenance Kit	8434 2136 73
RL18-MK	Ratchet Link Maintenance Kit	8434 2137 27
RL30-MK	Ratchet Link Maintenance Kit	8434 2138 23

Ratchet Link onderdelenlijst

#	Omschrijving	Part No.	#	Omschrijving	Part No.
1	Reaction Block Spacer	RTX-#45	14	Drive Pawl Primary	RTX-#22
2	Top Spacer	RTX-#46	15	Drive Pawl Secondary	RTX-#23
3	Reaction Pawl Spring Spacer	RTX-#47	16	Ratchet	RTX-#28
4	Reaction Pawl Spring	RTX-#37	17	Drive Pin	RTX-#33
5	Side Plate Roll Pin	RTX-#48	18	Drive Pin Spring	RTX-#34
6	Side Plate Screw Bottom	RTX-#50	19	Drive Spring Roll Pin	RTX-#32
7	Side Plate Screw Top	RTX-#51	20	Spring Seat	RTX-#49
8	Side Plate (left or right)	RTX-#52	21	Reaction Pawl Pin Assembly	RTX-#99
9	Drive Plate (left or right)	RTX-#35	22	Drive Plate Bushing	RTX-#89
10	Reaction Pawl	RTX-#36			
11	Shroud	RTX-#43			
12	Shroud Screw	RTX-#44			
13	Drive Pawl Spring	RTX-#27			

RT Ratchet Link bestaat uit:

Drive Pawl Primary, Drive Pawl Secondary, Drive Pawl Spring, Drive Pin Roll Spring, Drive Pin, Drive Pin Spring and Reaction Pawl Spring

