



Torcflex™ Clés Hydrauliques Nouvelle Génération

Les nouvelles clés hydrauliques Torcflex™ apportent d'importantes innovations sur le marché avec une sécurité et une ergonomie d'avant-garde !

MODELE TF

Clé à carré conducteur Premium



La nouvelle clé hydraulique Torcflex, la clé dont vous avez besoin sans le savoir.

Le marché de la clé hydraulique a connu peu ou pas de solutions innovantes au cours des 10 dernières années. La nouvelle gamme de clés dynamométriques Torcflex apporte innovation et révolution sur le marché du couple hydraulique avec une sécurité et une ergonomie pour les opérateurs.

Les nouvelles fonctionnalités incluent : Le **swivel coaxial**; cela réduira considérablement le temps de raccordement et augmentera la sécurité et la fiabilité. Un **bras de réaction mécaniquement lié**; cela éliminera le risque de chute et garantira que le bras de réaction reste sur l'outil.

Un **carré d'entraînement intégral** en 1 seule pièce, ce qui empêchera les risques de chute et la perte accidentelle de composants. Une nouvelle **poignée de support** réglable; celle-ci est incluse avec chaque clé.

A présent, toutes les clés hydrauliques TF sont **certifiées Atex** !



TF Series

Clé hydraulique dynamométrique

Les clés hydrauliques Atlas Copco TF Series offrent un couple élevé et précis ainsi qu'une fiabilité et une sécurité augmentée.



Monobloc aluminium housing

Housing léger et haute résistance : conçu pour offrir une rigidité et une résistance supérieures, ce qui se traduit par un excellent rapport couple/poids et durabilité. Le housing dispose de plusieurs points d'accueil pour la poignée de support.

Swivel et Raccords "Co-Axial "

Le lancement du système de swivel et de flexible "Co-Axial" est une solution innovante pour augmenter la productivité et réduire la fatigue de l'opérateur. Version à double pivot traditionnel en option disponible.

Bras de réaction solidaire

Empêche le risque de chute et permet un bon positionnement du bras de réaction dès la première fois.

Dent de retenue

Fonction "mains libres"
Augmente la précision et la sécurité.

Poignée Ergonomique

Multiple points d'attache-
ments
Le réglage et la rotation de la poignée améliorent la sécurité de l'opérateur.

Bras de réaction orientable sécurisé

orientation du bras facile et sans risque de chute

Carré d'entraînement avec retenue intégrée

Le carré intégral à changement rapide évite les risques de chute et la perte accidentelle du dispositif de retenue séparé.

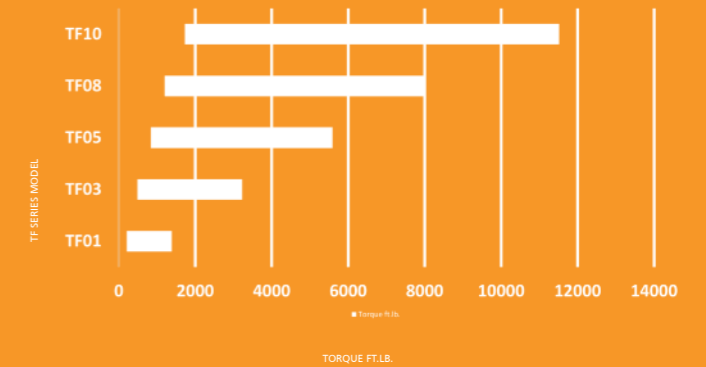

Square Drive Sizes

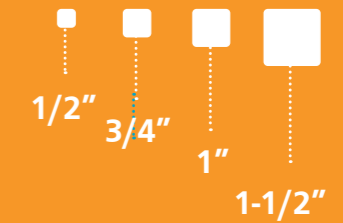

TF Series informations techniques



Modèle	Carré Conducteur		Couple		Poids		Ordering No Co-axial/Twin	
	in	ft. lb.	min	Nm	lb	kg		
TF01	3/4	209	1390	283	1885	6.06 / 6.44	2.75 / 2.92	8434 2406 05 / 8434 2410 15
TF03	1	485	3230	657	4379	12.06 / 12.43	5.47 / 5.64	8434 2409 95 / 8434 2409 94
TF05	1-1/2	839	5590	1137	7579	20.3 / 20.68	9.21 / 9.38	8434 2411 16 / 8434 2411 17
TF08	1-1/2	1200	8000	1627	10847	27.23 / 27.26	12.35 / 12.52	8434 2411 49 / 8434 2411 50
TF10	1-1/2	1728	11520	2343	15619	34.99 / 35.36	15.87 / 16.04	8434 2415 24 / 8434 2415 25

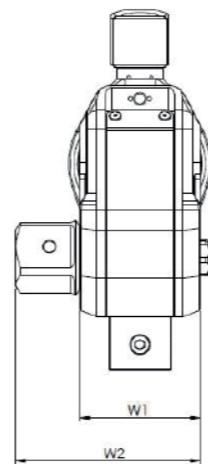
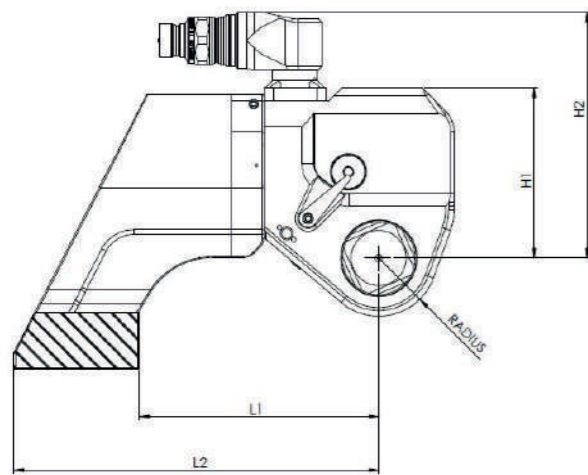

Model	Dimensions													
	L1		L2		H1		H2*		Rayon		W1		W2	
	in	mm	in	mm	in	mm	in	mm	in	mm	in	mm	in	mm
TF01	3.98	101	6.18	157	3.03	77	4.97 / 4.79	126 / 122	0.97	24.7	1.97	50	2.87	73
TF03	4.96	126	8.03	204	3.82	97	5.82 / 5.64	148 / 143	1.29	32.8	2.64	67	3.7	94
TF05	6.34	161	9.69	246	4.51	114.5	6.51 / 6.32	165 / 161	1.54	39.1	3.15	80	4.84	123
TF08	6.73	171	10.91	277	4.96	126.1	6.97 / 6.78	177 / 172	1.76	44.6	3.58	91	5.12	130
TF10	8.19	208	12.32	313	5.87	149	7.87 / 7.68	200 / 195	3.76	95.6	3.94	100	5.51	140

Designs and specifications are subject to change without notice or obligation. Read all safety instructions in the manual before usage.

*Values separated by slash are for model variants: Co-axial / Twin

TF Series standard setup

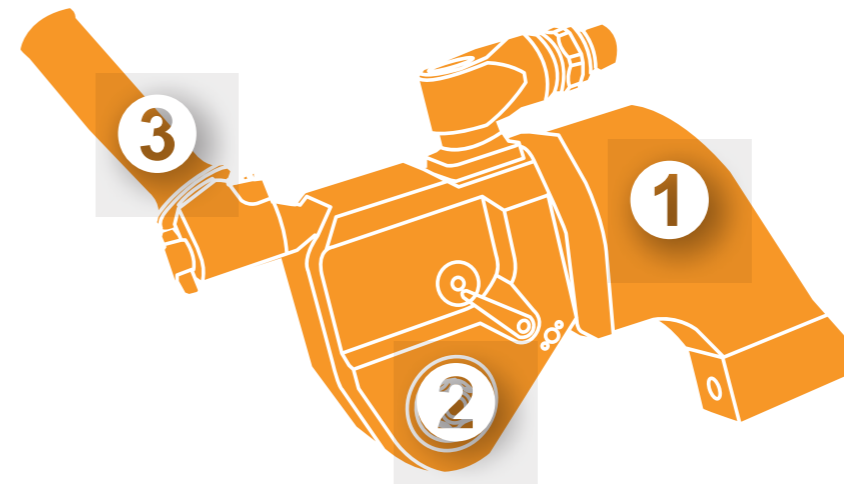

Toutes les clés TF sont fournies avec les équipements standards suivants:

1. Bras de réaction réglable et sécurisé
2. Carré conducteur intégral
3. Poignée de support ergonomique entièrement ajustable.
4. Emballage Peli-case avec mousse découpée.
5. Toutes les clés TF sont fournies avec le raccord Co-Axial de série

Utilisez des douilles à chocs de qualité!

Les clés hydrauliques de la série TF offrent un couple de sortie extrêmement élevé. Un excellent rapport puissance/poids et une gamme de 5 modèles couvrant un couple de 283 à 15 619 Nm (209 à 11 520 Ft. lb.).

TF & RT Series accessoires

7

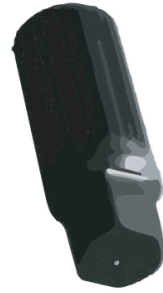

*Hexagones conducteurs
pour vis CHC*

Ordering No	Size	Description
8434 2101 72	1/2"	RT0.5-HX-008
8434 2138 44	10mm	RT0.5-HX-10MM
8434 2138 47	12mm	RT0.5-HX-12MM
8434 2138 50	14mm	RT0.5-HX-14MM
8434 2138 53	16mm	RT0.5-HX-16MM
8434 2138 56	17mm	RT0.5-HX-17MM
8434 2138 59	18mm	RT0.5-HX-18MM
8434 2138 62	19mm	RT0.5-HX-19MM
8434 2138 65	20mm	RT0.5-HX-20MM
8434 2138 68	22mm	RT0.5-HX-22MM
8434 2101 71	24mm	RT0.5-HX-24MM
8434 2138 71	5/8"	RT01-HX-010
8434 2138 74	3/4"	RT01-HX-012
8434 2138 77	7/8"	RT01-HX-014
8434 2056 94	1"	RT01-HX-100
8434 2138 83	10mm	RT01-HX-10MM
8434 2138 86	14mm	RT01-HX-14MM
8434 2138 89	16mm	RT01-HX-16MM
8434 2056 96	17mm	RT01-HX-17MM
8434 2138 92	18mm	RT01-HX-18MM
8434 2056 98	19mm	RT01-HX-19MM
8434 2057 00	20mm	RT01-HX-20MM
8434 2057 02	22mm	RT01-HX-22MM
8434 2057 04	24mm	RT01-HX-24MM
8434 2138 98	25mm	RT01-HX-25MM
8434 2138 95	26mm	RT01-HX-26MM
8434 2057 06	27mm	RT01-HX-27MM
8434 2057 14	5/8"	RT03-HX-010
8434 2057 16	3/4"	RT03-HX-012
8434 2057 18	7/8"	RT03-HX-014
8434 2057 20	1"	RT03-HX-100
8434 2139 28	1 1/8"	RT03-HX-102
8434 2139 31	1 1/4"	RT03-HX-104
8434 2139 34	1 1/2"	RT03-HX-108
8434 2139 35	15mm	RT03-HX-15MM
8434 2139 36	16mm	RT03-HX-16MM
8434 2139 37	17mm	RT03-HX-17MM
8434 2057 22	19mm	RT03-HX-19MM
8434 2057 24	22mm	RT03-HX-22MM
8434 2057 26	24mm	RT03-HX-24MM
8434 2139 43	26mm	RT03-HX-26MM
8434 2057 28	27mm	RT03-HX-27MM
8434 2139 46	30mm	RT03-HX-30MM
8434 2057 30	32mm	RT03-HX-32MM
8434 2139 49	36mm	RT03-HX-36MM

Ordering No	Size	Description
8434 2139 55	38mm	RT03-HX-38MM
8434 2139 58	41mm	RT03-HX-41MM
8434 2139 61	46mm	RT03-HX-46MM
8434 2139 64	55mm	RT03-HX-55MM
8434 2140 04	1"	RT-05
8434 2140 13	1 1/4"	RT05-HX-104
8434 2139 97	19mm	RT05-HX-19MM
8434 2140 00	22mm	RT05-HX-22MM
8434 2140 03	24mm	RT05-HX-24MM
8434 2140 06	26mm	RT05-HX-26MM
8434 2057 36	27mm	RT05-HX-27MM
8434 2140 10	30mm	RT05-HX-30MM
8434 2140 12	32mm	RT05-HX-32MM
8434 2057 38	36mm	RT05-HX-36MM
8434 2057 39	38mm	RT05-HX-38
8434 2057 40	41mm	RT05-HX-41MM
8434 2057 42	46mm	RT05-HX-46MM
8434 2140 20	50mm	RT05-HX-50MM
8434 2140 21	55mm	RT05-HX-55MM
8434 2140 45	24mm	RT08-HX-24MM
8434 2140 48	27mm	RT08-HX-27MM
8434 2140 69	1"	RT10-HX-100
8434 2140 72	1 1/2"	RT10-HX-108
8434 2140 75	32mm	RT10-HX-32MM
8434 2057 46	36mm	RT10-HX-36MM
8434 2057 48	41mm	RT10-HX-41MM
8434 2057 50	46mm	RT10-HX-46MM
8434 2057 52	50mm	RT10-HX-50MM
8434 2140 81	55mm	RT10-HX-55MM

Dimensions Hex drive

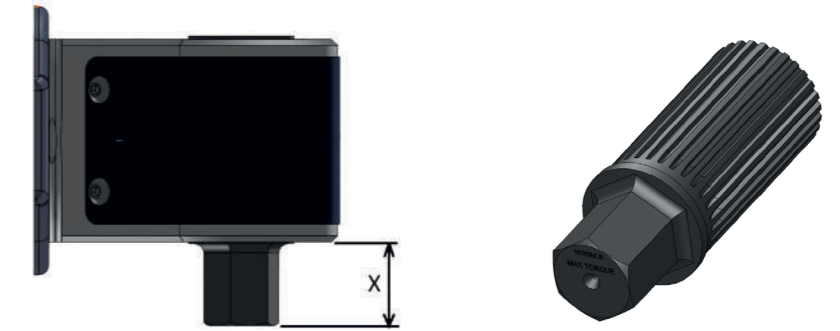

RT Hex Drives - Inch Series

Wrench Ref	Hex AF inch	X inch	Max Torque lbf.ft
RT-0.5	3/8	0.472	149
RT-0.5	7/16	0.512	236
RT-0.5	1/2	0.551	353
RT-0.5	5/8	0.591	689
RT-01	5/8	0.709	689
RT-01	3/4	0.827	1191
RT-01	7/8	0.945	1892
RT-01	1	1.063	2824
RT-03	3/4	0.906	1191
RT-03	7/8	1.024	1892
RT-03	1	1.142	2824
RT-03	1 1/4	1.299	5516
RT-05	1	1.142	2824
RT-05	1 1/4	1.299	5516
RT-05	1 1/2	1.417	9531
RT-05	1 3/4	1.614	15135
RT-08	1	1.142	2824
RT-08	1 1/4	1.299	5516
RT-08	1 1/2	1.417	9531
RT-08	1 3/4	1.614	15135
RT-10	1 1/4	1.339	5516
RT-10	1 1/2	1.457	9531
RT-10	1 3/4	1.654	15135
RT-10	2	1.850	22593

RT Hex Drives - Metric Series

Wrench Ref	Hex AF mm	X mm	Max Torque Nm
RT-0.5	10	12	234
RT-0.5	12	13	404
RT-0.5	14	14.5	641
RT-0.5	17	16	1147
RT-01	17	19	1147
RT-01	19	21	1602
RT-01	22	24.5	2486
RT-01	27	28	4596
RT-03	19	23	1602
RT-03	22	26.5	2486
RT-03	27	30	4596
RT-03	32	35	7652
RT-05	27	30	4596
RT-05	32	35	7652
RT-05	36	39	10895
RT-05	41	45	16094
RT-08	27	30	4596
RT-08	32	35	7652
RT-08	36	39	10895
RT-08	41	45	16094
RT-10	32	36	7652
RT-10	36	40	10895
RT-10	41	46	16094
RT-10	46	50	22730
RT-10	50	52	29190

MODELE TFX

Clé à cassettes Premium



La clé dynamométrique hydraulique Torcflex, la meilleure de sa catégorie en matière de sécurité et de fiabilité.

La clé dynamométrique hydraulique à cassettes Torcflex est rapide, facile à installer et parfaite pour les applications à encombrements réduits et difficiles d'accès.

La clé Torcflex peut être équipée en standard des configurations coaxiales ou doubles. Il existe des avantages supplémentaires en matière de sécurité et une efficacité accrue pour l'utilisateur, grâce à la goupille de liaison retenue et à la poignée de support proposées en standard.



MODELE TFX

Clés hydrauliques dynamométriques

Les clés dynamométriques hydrauliques à profil bas série TFX d'Atlas Copco éliminent les problèmes avec des dégagements restreints, tout en augmentant l'efficacité des utilisateurs.



Powerhead

Fabriqué à partir d'un alliage de qualité aéronautique pour un rapport résistance/poids optimal. Peut être utilisé avec les Cassettes RTX.

Raccord Co-Axial

Le lancement du système de swivel et de flexible Co-Axial est une solution innovante pour augmenter la productivité et réduire la fatigue de l'opérateur. Version traditionnelle à double pivot en option disponible.

Cassettes interchangeables

Fabriquées en acier premium pour une meilleure durabilité et interchangeables avec les modèles RTX.

Dent de retenue

Fonction "mains libres" augmente la précision de serrage.

Axe de liaison intégré

La conception brevetée élimine le risque de chute et empêche le désengagement accidentel des broches.

Rayon réduit

L'utilisation d'acier de qualité supérieure permet d'optimiser les cassettes pour permettre un ajustement sur des applications à faible dégagement.

Poignée Ergonomique

Le réglage et la rotation de la poignée améliorent la sécurité de l'opérateur.

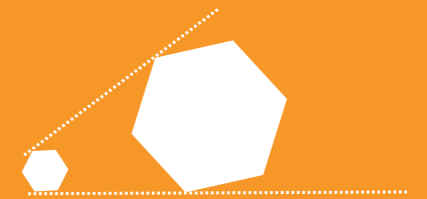
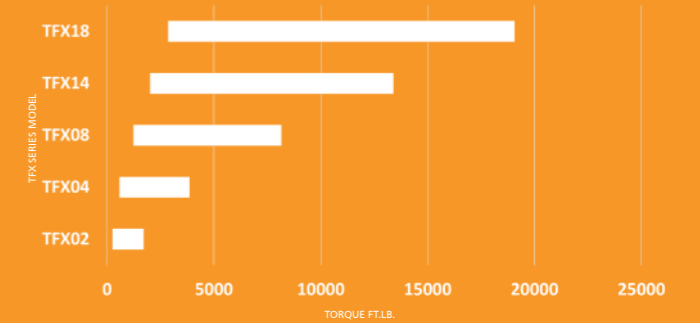

Gamme de 3/4" – 5 3/8"
15mm à 135mm AF

TFX Series informations techniques

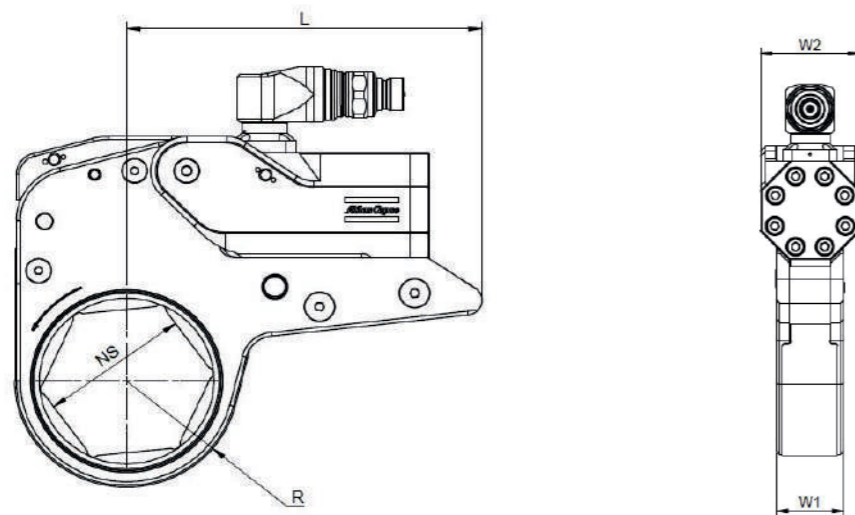

Model	Dimensions					
	L		W1		W2	
	in	mm	in	mm	in	mm
TFX02	5.49	140	1.26	32	1.81	46
TFX04	7.5	191	1.68	43	2.40	61
TFX08	9.24	235	2.08	53	3.07	78
TFX14	11.23	285	2.48	63	3.62	92
TFX18	12.69	322	2.75	70	4.13	105

* TFX30 detail coming June 2023

Model	Tailles de cassettes*		Couple		Poids (sans cassette)		Ordering No . Co-Axial/Twin
	in	mm	ft.lb.	Nm	lb	kg	
TFX02	3/4" - 2-9/16"	15-65	257-1710	348-2318	2.47 / 2.89	1.12 / 1.31	8434 2406 68 / 8434 2419 75
TFX04	3/4" - 3-3/16"	15-80	579-3855	784-5227	4.32 / 4.72	1.96 / 2.14	8434 2411 47 / 8434 2419 76
TFX08	1 1/8" - 3-7/8"	30-100	1223-8151	1658-11051	7.25 / 7.63	3.29 / 3.46	8434 2417 87 / 8434 2420 70
TFX14	1 1/4" - 4-5/8"	32-120	2010-13400	2725-18168	11.24 / 11.62	5.1 / 5.27	8434 2424 02 / 8434 2424 05
TFX18	2 3/16" - 5 3/8"	55-135	2861-19074	3879-25861	15.26 / 15.61	6.92 / 7.08	8434 2427 13 / 8434 2427 32

Designs and specifications are subject to change without notice or obligation. Read all safety instructions in the manual before usage.

Choisir votre clé hydraulique dynamométrique TFX

1

TFX Powerhead

Toutes les Têtes TFX sont fournies avec les équipements standards suivants:

1. Poignée ergonomique ajustable
2. Axe de liaison intégrée sur cassette.
3. Valise Peli-case et mousse découpée.
4. Voulez-vous une connexion Co-axial ou traditionnelle à 2 raccords? les 2 sont possibles.

2

Cassette TL

Choisissez la taille pour votre application. Egalement fournie avec une valise Peli-case

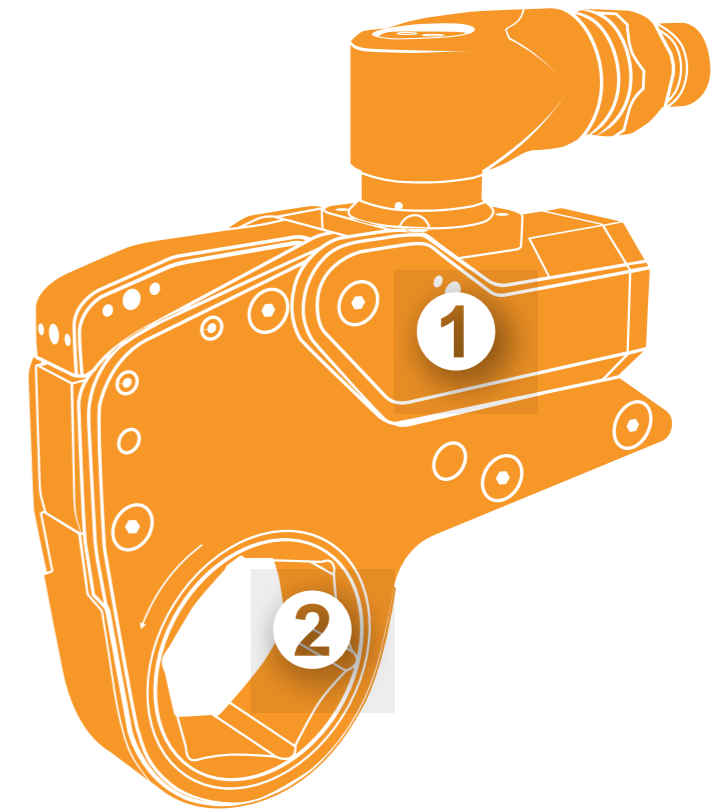

Large gamme de cassettes diponible pour toutes vos applications compatibles avec 5 têtes hydrauliques avec un couple de 348 à 25861 Nm

Contactez-nous pour toute demande spécifique, nous nous ferons un plaisir d'y répondre.

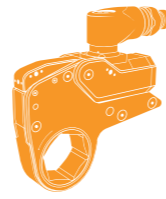

TFX02 Ratchet link sizes

Nominal Hexagon A/F Inch	Link Metric	Link Ref.	Nose Radius 'R' [in] (Decimal)	Nose Radius 'R' [mm] (Decimal)	Model	Ordering No.
15	#1	#1	1.037	26.34	TL02-15MM	8434242653
17	#1	#1	1.037	26.34	TL02-17MM	8434242505
3/4"	19	#1	1.037	26.34	TL02-012/19MM	8434242506
13/16"	#1	#1	1.037	26.34	TL02-013	8434242507
7/8"	22	#1	1.037	26.34	TL02-014/22MM	8434242508
15/16"	24	#1	1.037	26.34	TL02-24MM	8434242509
1"	#1	#1	1.037	26.34	TL02-100	8434242510
1-1/16"	27	#1	1.037	26.34	TL02-101/27MM	8434241763
1-1/8"	#1	#1	1.037	26.34	TL02-102	8434242511
1-3/16"	30	#2	1.118	28.40	TL02-103/30MM	8434242512
1-1/4"	32	#2	1.118	28.40	TL02-104/32MM	8434241764
1-5/16"	#3	#3	1.219	30.96	TL02-105	8434242513
34	#3	#3	1.219	30.96	TL02-34MM	8434242514
1-7/16"	36	#3	1.219	30.96	TL02-107/36MM	8434241765
1-1/2"	#4	#4	1.329	33.76	TL02-108	8434242515
1-9/16"	#4	#4	1.329	33.76	TL02-109	8434242516
1-5/8"	41	#4	1.329	33.76	TL02-110/41MM	8434241766
1-11/16"	#5	#5	1.436	36.47	TL02-111	8434242517
1-3/4"	#5	#5	1.436	36.47	TL02-112	8434242518
1-13/16"	46	#5	1.436	36.47	TL02-113/46MM	8434241767
1-7/8"	#6	#6	1.548	39.32	TL02-114	8434242519
1-15/16"	#6	#6	1.548	39.32	TL02-115	8434242520
2"	50	#6	1.548	39.32	TL02-50MM	8434241801
2-1/16"	#7	#7	1.657	42.09	TL02-201	8434242522
2-1/8"	#7	#7	1.657	42.09	TL02-202	8434242523
2-3/16"	55	#7	1.657	42.09	TL02-203/55MM	8434241769
2-1/4"	#8	#8	1.767	44.88	TL02-204	8434242524
58	#8	#8	1.767	44.88	TL02-58MM	8434242525
2-5/16"	#8	#8	1.767	44.88	TL02-205	8434242526
2-3/8"	60	#8	1.767	44.88	TL02-206/60MM	8434241770
2-7/16"	#9	#9	1.877	47.68	TL02-207	8434242527
2-1/2"	#9	#9	1.877	47.68	TL02-208	8434242528
2-9/16"	65	#9	1.877	47.68	TL02-209/65MM	8434242451

Autres tailles disponibles sur demande.

TFX04 Ratchet link sizes

Nominal Hexagon A/F Inch	Link Metric	Link Ref.	Nose Radius 'R' [in] (Decimal)	Nose Radius 'R' [mm] (Decimal)	Model	PTD Ordering No.
15	#1	#1	1.335	33.91	TL04-15MM	8434242529
17	#1	#1	1.335	33.91	TL04-17MM	8434242530
3/4"	19	#1	1.335	33.91	TL04-012/19MM	8434242531
13/16"	#1	#1	1.335	33.91	TL04-013	8434242532
7/8"	22	#1	1.335	33.91	TL04-014/22MM	8434242533
15/16"	24	#1	1.335	33.91	TL04-24MM	8434242534
1"	#1	#1	1.335	33.91	TL04-100	8434242535
1-1/16"	27	#1	1.335	33.91	TL04-101/27MM	8434242536
1-1/8"	#1	#1	1.335	33.909	TL02-102	8434242537
1-3/16"	30	#1	1.335	33.91	TL04-103/30MM	8434242538
1-1/4"	32	#1	1.335	33.91	TL04-104/32MM	8434242539
1-5/16"	#1	#1	1.335	33.91	TL04-105	8434242540
1-7/16"	36	#1	1.335	33.91	TL04-107/36MM	8434241771
1-1/2"	#2	#2	1.444	36.68	TL04-108	8434242541
1-9/16"	#2	#2	1.444	36.68	TL04-109	8434242542
1-5/8"	41	#2	1.444	36.68	TL04-110/41MM	8434241772
1-11/16"	#3	#3	1.552	39.42	TL04-111	8434242543
1-3/4"	#3	#3	1.552	39.42	TL04-112	8434242544
1-13/16"	46	#3	1.552	39.42	TL04-113/46MM	8434241773
1-7/8"	#4	#4	1.662	42.21	TL04-114	8434242545
1-15/16"	#4	#4	1.662	42.21	TL04-115	8434242546
2"	50	#4	1.662	42.21	TL04-50MM	8434242072
2-1/16"	#5	#5	1.772	45.01	TL04-200	8434241774
2-1/8"	#5	#5	1.772	45.01	TL04-201	8434242547
2-3/16"	55	#5	1.772	45.01	TL04-202	8434242548
2-1/4"	#6	#6	1.882	47.80	TL04-203/55MM	8434241775
58	#6	#6	1.882	47.80	TL04-204	8434242549
2-5/16"	#6	#6	1.882	47.80	TL04-58MM	8434242550
2-3/8"	60	#6	1.882	47.80	TL04-205	8434242551
2-7/16"	#7	#7	1.991	50.57	TL04-206/60MM	8434241776
2-1/2"	#7	#7	1.991	50.57	TL04-207	8434242552
2-9/16"	65	#7	1.991	50.57	TL04-208	8434242553
2-5/8"	#8	#8	2.101	53.37	TL04-209/65MM	8434241777
2-3/4"	70	#8	2.101	53.37	TL04-210	8434242554
2-13/16"	#9	#9	2.218	56.34	TL04-212/70MM	8434241778
2-15/16"	75	#9	2.218	56.34	TL04-213	8434242555
3"	#10	#10	2.331	59.21	TL04-215/75MM	8434241779
77	#10	#10	2.331	59.21	TL04-300	8434242556
3-1/16"	78	#10	2.331	59.21	TL04-77MM	8434242557
3-1/8"	80	#10	2.331	59.21	TL04-301	8434242558
#10	#10	#10	2.331	59.21	TL04-302/80MM	8434241780
#10	#10	#10	2.331	59.21	TL04-303	8434242559

Autres tailles disponibles sur demande.

TFX08 Ratchet link sizes

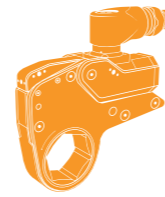

Nominal Hexagon Inch	A/F Metric	Link Ref.	Nose Radius 'R' [in] (Decimal)	Nose Radius 'R' [mm] (Decimal)	Model	Ordering No.
1-1/8"		#1	1.777	45.14	TL08-102	8434242560
1-3/16"	30	#1	1.777	45.14	TL08-103/30MM	8434242561
1-1/4"	32	#1	1.777	45.14	TL08-104/32MM	8434242562
1-5/16"		#1	1.777	45.14	TL08-105	8434242563
1-7/16"	36	#1	1.777	45.14	TL08-107/36MM	8434242564
1-1/2"		#1	1.777	45.14	TL08-108	8434242565
1-9/16"		#1	1.777	45.14	TL08-109	8434242566
1-5/8"	41	#1	1.777	45.14	TL08-110/41MM	8434242567
1-11/16"		#1	1.777	45.14	TL08-111	8434242568
1-3/4"		#1	1.777	45.14	TL08-112	8434242569
1-13/16"	46	#1	1.777	45.14	TL08-113/46MM	8434242570
1-7/8"		#1	1.777	45.14	TL08-114	8434242571
1-15/16"		#1	1.777	45.14	TL08-115	8434242572
2"	50	#1	1.777	45.14	TL08-50MM	8434241805
2-1/16"		#2	1.886	47.90	TL08-201	8434242573
2-1/8"		#2	1.886	47.90	TL08-202	8434242574
2-3/16"	55	#2	1.886	47.90	TL08-203/55MM	8434241806
2-1/4"		#3	1.995	50.67	TL08-204	8434242575
2-5/16"		#3	1.995	50.67	TL08-205	8434242576
2-3/8"	60	#3	1.995	50.67	TL08-206/60MM	8434241807
2-7/16"		#4	2.105	53.47	TL08-207	8434242577
2-1/2"		#4	2.105	53.47	TL08-208	8434242578
2-9/16"	65	#4	2.105	53.47	TL08-209/65MM	8434241808
2-5/8"		#5	2.215	56.26	TL08-210	8434242579
2-3/4"	70	#5	2.215	56.26	TL08-212/70MM	8434241809
2-13/16"		#6	2.332	59.23	TL08-213	8434242580
2-15/16"	75	#6	2.332	59.23	TL08-215/75MM	8434241810
3"		#7	2.445	62.10	TL08-300	8434242581
		#7	2.445	62.10	TL08-77MM	8434242582
3-1/16"	78	#7	2.445	62.10	TL08-78MM	8434242583
3-1/8"	80	#7	2.445	62.10	TL08-302/80MM	8434242584
	85	#8	2.567	65.20	TL08-85MM	8434241812
3-3/8"		#8	2.567	65.20	TL08-306	8434242585
3-1/2"		#9	2.673	67.89	TL08-308	8434241813
	90	#9	2.673	67.89	TL08-90MM	8434241814
3-5/8"		#10	2.797	71.04	TL08-310	8434242586
3-3/4"	95	#10	2.797	71.04	TL08-312/95MM	8434241815
3-7/8"		#11	2.900	73.66	TL08-314	8434241816
	100	#11	2.900	73.66	TL08-100MM	8434241817

Autres tailles disponibles sur demande.

TFX14 Ratchet link sizes

Nominal Hexagon Inch	A/F Metric	Link Ref.	Nose Radius 'R' [in] (Decimal)	Nose Radius 'R' [mm] (Decimal)	Model	Ordering No.
1-1/4"	32	#1	2.331	59.21	TL14-104/32MM	8434242587
1-1/2"		#1	2.331	59.21	TL14-108	8434242588
1-9/16"		#1	2.331	59.21	TL14-109	8434242589
1-5/8"	41	#1	2.331	59.21	TL14-110/41MM	8434242590
1-11/16"		#1	2.331	59.21	TL14-111	8434242591
1-3/4"		#1	2.331	59.21	TL14-112	8434242592
1-13/16"	46	#1	2.331	59.21	TL14-113/46MM	8434242593
1-7/8"		#1	2.331	59.21	TL14-114	8434242594
	50	#1	2.331	59.21	TL14-50MM	8434242595
2"		#1	2.331	59.21	TL14-200	8434242596
2-3/16"	55	#1	2.331	59.21	TL14-203/55MM	8434242597
2-1/4"		#1	2.331	59.21	TL14-204	8434242598
2-3/8"	60	#1	2.331	59.21	TL14-206/60MM	8434242599
2-1/2"		#1	2.331	59.21	TL14-208	8434242600
2-9/16"	65	#1	2.331	59.21	TL14-209/65MM	8434242601
2-5/8"		#1	2.331	59.21	TL14-210	8434242602
2-3/4"	70	#1	2.331	59.21	TL14-212/70MM	8434242134
2-13/16"		#2	2.447	62.15	TL14-213	8434242603
2-15/16"	75	#2	2.447	62.15	TL14-215/75MM	8434242135
3"		#3	2.561	65.05	TL14-300	8434242604
	77	#3	2.561	65.05	TL14-77MM	8434242605
3-1/16"	78	#3	2.561	65.05	TL14-301	8434242606
3-1/8"	80	#3	2.561	65.05	TL14-302/80MM	8434242136
3-3/16"		#4	2.682	68.12	TL14-303	8434242607
	85	#4	2.682	68.12	TL14-85MM	8434242137
3-3/8"		#4	2.682	68.12	TL14-306	8434242608
3-1/2"		#5	2.788	70.82	TL14-308	8434242138
	90	#5	2.788	70.82	TL14-90MM	8434242139
3-5/8"		#6	2.913	73.99	TL14-310	8434242609
3-11/16"		#6	2.913	73.99	TL14-311	8434242610
3-3/4"	95	#6	2.913	73.99	TL14-312/95MM	8434242140
3-7/8"		#7	3.015	76.58	TL14-314	8434242141
	100	#7	3.015	76.58	TL14-100MM	8434242142
4-1/16"		#8	3.132	79.55	TL14-401	8434242611
4-1/8"		#8	3.132	79.55	TL14-402	8434242612
	105	#8	3.132	79.55	TL14-105MM	8434242143
4-3/16"		#9	3.246	82.45	TL14-403	8434242613
4-1/4"		#9	3.246	82.45	TL14-404	8434242144
	110	#9	3.246	82.45	TL14-110MM	8434242145
4-1/2"		#10	3.473	88.20	TL14-408	8434242614
	115	#10	3.473	88.20	TL14-115MM	8434242146
4-5/8"		#10	3.473	88.20	TL14-410	8434242147
	120	#10	3.473	88.20	TL14-120MM	8434242148

Autres tailles disponibles sur demande.

TFX18 Ratchet link sizes

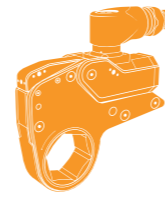

Nominal Hexagon Inch	A/F Metric	Link Ref.	Nose Radius 'R' [in] (Decimal)	Nose Radius 'R' [mm] (Decimal)	Model	Ordering No.
2-3/16"	55	#1	2.572	65.32	TL18-203/55MM	8434242615
2-1/4"		#1	2.572	65.32	TL204	8434242616
2-3/8"	60	#1	2.572	65.32	TL18-206/60MM	8434242617
2-1/2"		#1	2.572	65.32	TL18-208	8434242618
2-9/16"	65	#1	2.572	65.32	TL18-209/65MM	8434242619
2-5/8"		#1	2.572	65.32	TL18-210	8434242620
2-3/4"	70	#1	2.572	65.32	TL18-212/70MM	8434242621
2-13/16"		#1	2.572	65.32	TL18-213	8434242622
2-15/16"	75	#1	2.572	65.32	TL18-215/75MM	8434242623
3"		#1	2.572	65.32	TL18-300	8434242624
	77	#2	2.685	68.20	TL18-77MM	8434242625
3-1/16"	78	#2	2.685	68.20	TL18-301	8434242626
3-1/8"	80	#2	2.685	68.20	TL18-302/80MM	8434242627
3-3/16"		#3	2.913	73.98	TL18-303	8434242628
	85	#3	2.913	73.98	TL18-85MM	8434242629
3-3/8"		#3	2.913	73.98	TL18-306	8434242630
3-1/2"		#3	2.913	73.98	TL18-308	8434242631
	90	#3	2.913	73.98	TL18-90MM	8434242632
3-5/8"		#4	3.140	79.74	TL18-310	8434242633
3-11/16"		#4	3.140	79.74	TL18-311	8434242634
3-3/4"	95	#4	3.140	79.74	TL18-312/95MM	8434242635
3-7/8"		#4	3.140	79.74	TL18-314	8434242636
	100	#4	3.140	79.74	TL18-100MM	8434242637
4-1/16"		#5	3.371	85.61	TL18-401	8434242638
4-1/8"		#5	3.371	85.61	TL18-402	8434242639
	105	#5	3.371	85.61	TL18-105MM	8434242640
4-3/16"		#5	3.371	85.61	TL18-403	8434242641
4-1/4"		#5	3.371	85.61	TL18-404	8434242642
	110	#5	3.371	85.61	TL18-110MM	8434242643
4-1/2"		#6	3.598	91.39	TL18-408	8434242644
	115	#6	3.598	91.39	TL18-115MM	8434242645
4-5/8"		#6	3.598	91.39	TL18-410	8434242646
	120	#7	3.816	96.91	TL18-120MM	8434242647
5"		#7	3.816	96.91	TL18-500	8434242648
	130	#8	3.985	101.22	TL18-130MM	8434242649
	135	#8	3.985	101.22	TL18-135MM	8434242650
5-3/8"		#8	3.985	101.22	TL18-506	8434242651

Autres tailles disponibles sur demande.

TFX30 Ratchet link sizes

Nominal Hexagon Inch	A/F Metric	Link Ref.	Nose Radius 'R' [in] (Decimal)	Nose Radius 'R' [mm] (Decimal)	Model	Ordering No.
2-9/16"	65	#1	3.029	76.94	TL30-209/65MM	8434242652
2-5/8"		#1	3.029	76.94	TL30-210	8434242653
2-3/4"	70	#1	3.029	76.94	TL30-212/70MM	8434242654
2-13/16"		#1	3.029	76.94	TL30-213	8434242655
2-15/16"	75	#1	3.029	76.94	TL30-215/75MM	8434242656
3"		#1	3.029	76.94	TL30-300	8434242657
	77	#1	3.029	76.94	TL30-77MM	8434242658
3-1/16"	78	#1	3.029	76.94	TL30-301	8434242659
3-1/8"	80	#1	3.029	76.94	TL30-302/80MM	8434242660
3-3/16"		#1	3.029	3.029	TL30-303	8434242661
	85	#1	3.029	76.94	TL30-85MM	8434242662
3-3/8"		#1	3.029	76.94	TL30-306	8434242663
3-1/2"		#1	3.029	76.94	TL30-308	8434242664
	90	#2	3.256	82.70	TL30-90MM	8434242665
3-5/8"		#2	3.256	82.70	TL30-310	8434242666
3-11/16"		#2	3.256	82.70	TL30-311	8434242667
3-3/4"	95	#2	3.256	82.70	TL30-312/95MM	8434242668
3-7/8"		#2	3.256	82.70	TL30-314	8434242669
	100	#2	3.256	82.70	TL30-100MM	8434242670
4-1/16"		#3	3.487	88.57	TL30-401	8434242671
4-1/8"		#3	3.487	88.57	TL30-402	8434242672
	105	#3	3.487	88.57	TL30-105MM	8434242673
4-3/16"		#3	3.487	88.57	TL30-403	8434242674
4-1/4"		#3	3.487	88.57	TL30-404	8434242675
	110	#3	3.487	88.57	TL30-110MM	8434242676
4-1/2"		#4	3.713	94.31	TL30-408	8434242677
	115	#4	3.713	94.31	TL30-115MM	8434242678
4-5/8"		#4	3.713	94.31	TL30-410	8434242679
	120	#5	3.941	100.10	TL30-120MM	8434242680
5"		#5	3.941	100.10	TL30-500	8434242681
	130	#6	4.101	104.17	TL30-130MM	8434242682
	135	#6	4.101	104.17	TL30-135MM	8434242683
5-3/8"		#6	4.101	104.17	TL30-506	8434242684
	140	#7	4.320	109.73	TL30-140MM	8434242685
	145	#7	4.320	109.73	TL30-145MM	8434242686
5-3/4"		#7	4.320	109.73	TL30-512	8434242687
	150	#8	4.537	115.24	TL30-150MM	8434242688
5-15/16"		#8	4.537	115.24	TL30-515	8434242689
6-1/8"	155	#8	4.537	115.24	TL30-602/155MM	8434242690

Autres tailles disponibles sur demande.



First Bolting s.p.r.l.

Avenue Newton, 8
B-1300 Wavre - Belgium

Tél. +32(0)2.358.19.33
email: info@1bolting.com



Belgique: 0800 112 12
France: 0800 90 18 51